



NOCO™

POLYMERIC JOINT

UPDATE

June 8th, 2023

Make sure that you have an up-to-date technical data sheet in hand by consulting our website: techniseal.com
U.S.A. and Canada: dial 1 800 465-7325
Others: dial (514) 523-8324 (Canada)

APPLICATIONS

- Natural stones, wet cast pavers, concrete pavers, highly textured surfaces, large slabs and porcelain tiles
- For all types of installations including draining base, cement/sand bedding, and concrete overlays
- Ideal for installation with the NextBase™ paver base panel system
- False joints
- Joint width from 6-100* mm (1/4" to 4")*

*For joint narrower than 6 mm (1/4"), please contact Techniseal®. Recommended joint width for flagstone is up to 50 mm (2") with interstice up to 100 mm (4").

- Residential and commercial projects: Follow stone or paver's manufacturer recommendations.
- For vehicular traffic. Mechanical compaction is not prohibited and will enhance performance.

PROPERTIES

- Fast wetting
- Optimal strength
- Deters ants and other insects
- Inhibits weed growth
- Eliminates joint erosion – water, frost heaving, wind, cleaning, etc.

DESCRIPTION

Techniseal® NOCO™ is the first jointing sand product specifically developed for projects where mechanical compaction is either not possible or traditionally not used.

Ideal for flagstones, wet cast pavers (such as imitation European cobblestone), large slabs, false joints and porcelain tiles; NOCO™ can be used on concrete overlay or cement-sand base bedding. It is a clean, easy and fast alternative to mortar and stone dust jointing.



Techniseal® Jointing sands contribute to LEED credits, based on the use of regional and recycled materials.

DIRECTIONS

ALWAYS TEST on a small hidden area of approximately 4 sq. ft. to ensure that result meets your expectations (see Warranty). For installation with natural stone, wait two days after installation to confirm that there is no halo appearing at the perimeter of the stones created by migration of moisture throughout the installation. This “moisture effect” is not to be confused with “picture frame” that can also be described as a halo effect on the outline of the stones. The difference being that “picture frame” is a permanent and irreversible migration of ingredients from the jointing compound inside the porous matrix of the natural stone or substrate. This is a phenomenon known with all jointing systems such as mortars, epoxy joints and others.

BEFORE YOU BEGIN

Due to the unique nature of this material, it is mandatory that the installation be protected from rain for **24 hours** after installation. For wider joints and installation in colder temperature, **48 hours** without rain may be required.

Installation Conditions: Temperature must be above 10°C (50°F) for 48 hours following installation. • Surface and joints must be dry. • Sprinkler system must be turned off.

Traffic: Pedestrian: Immediate / Vehicular: 48 to 72 h. Block access during that period.

Necessary Tools:

- Street broom with semi-rigid bristles
- Leaf blower
- Spray nozzle and garden hose
- Small soft brush for smoothing down the joints before activation

CAUTION

- Wear appropriate safety gears.
- Do not mix product with cement, sand or any other material.
- **Wait for a minimum of 7 days** after installation and ensure that joint has hardened before cleaning and sealing the surface.
- Do not use on submerged or constantly wet surfaces.
- Because product comes from a natural source, colour and grain size may vary.
- **IMPORTANT:** Do not use this product as capping sand.
- The use of cleaning devices (high-pressure washer, etc.) is restricted during the first 30 days. It should be noted that too direct and violent jets can create alterations, so it is best to consult the machine manufacturers in order to use the specific accessories with soft jets.
- If using on natural stone that has a very porous texture, it is particularly important that the surface be very dry before applying NOCO™. Failure to do so may cause staining that will be very difficult to remove or may require cleaning products that can potentially damage the surface of the stone.
- Proper maintenance is paramount to maintaining joints in optimal condition. Excessive moisture, shade, inadequate cleaning and maintenance, presence of soil and organic matters (including grass trimmings) left on the joints may contribute to growth of moss, mold or mildew and a premature deterioration of the jointing product.

INSTALLATION ON A DRAINING BASE WITH JOINT WIDTH FROM 6 mm (1/4”) TO 100 mm (4”)

NOTE: For installation on concrete overlay, please see [sub-section further down](#).

The hardscape products should be installed following the manufacturer’s recommendation. Prior to applying NOCO™, make sure that the pavers, stones or slabs are well embedded in the bedding layer. For **flagstone**, the Natural Stone Institute guideline should be followed (www.naturalstoneinstitute.org). For **pavers and slabs**, ICPI Technical Specification Spec #2 (www.icpi.org) should be used.

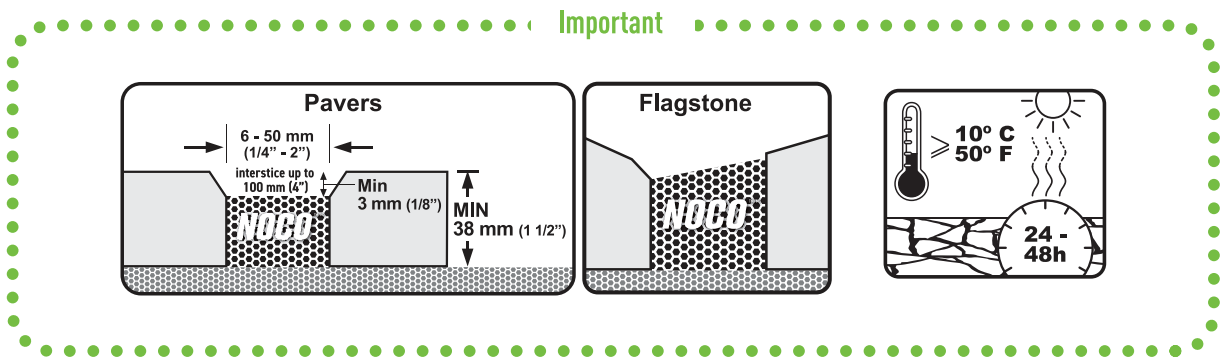

Installation - Important

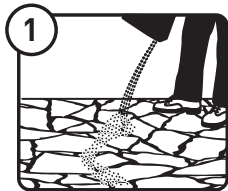

Spread product evenly on a small surface.

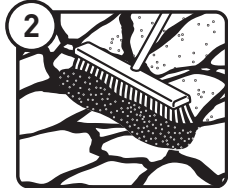

Using the street broom, fill joints completely. Sweep NOCO™ over **short distances**.



Remove excess NOCO™ from the surface with the broom.

Optional

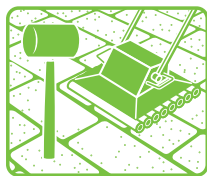

A slab and paver roller compactor or a rubber mallet can be used to compact NOCO™.

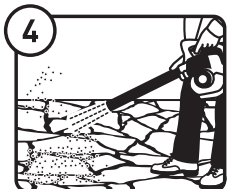

Level the joint height of NOCO™ and **remove all NOCO™ residue from the surface with the leaf blower.**

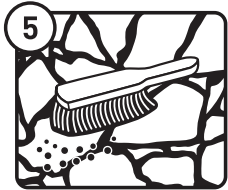

Using the small brush, smooth down the NOCO™ joint to ensure a uniform finish after activation.

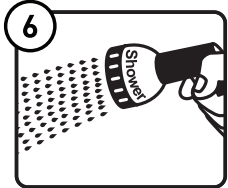

For joints up to 13 mm (1/2"): wet 30 sec/9,2 m² (100 sq. ft.).

For joints 13-100 mm (1/2" to 4"): wet up to 60 sec/4,5 m² (50 sq. ft.). Stop showering when you see water retention on the joints.

NOCO™ ACTIVATION INSTRUCTION FOR TYPICAL INSTALLATION ON DRAINING BASE

For Flagstones with joints up to 50 mm (2”), intersecting spaces up to 100 mm (4”) and stone thickness up to 50 mm (2”): with your sprayer set at shower, starting at the bottom of the slope, **water each section of 4.5 m² (50 sq. ft.) for 45 to 60 seconds**. Check for water accumulation at the surface of the jointing product as a cue to stop watering. Wait 30 seconds and verify the depth of activation. If NOCO™ is activated at 75% or more of its depth stop watering. If not, water for an additional 15 seconds. Adjust watering time for the next sections. Aim to achieve complete saturation of the joint in one pass. Overwetting the joint will lengthen the cure time.

For imitation European cobblestones with joint with approximately 13 mm (½”) and joint depth 38 mm (1 ½”): with your sprayer set at shower, starting at the bottom of the slope, **water each section of 9.2 m² (100 sq. ft.) for 20 to 30 seconds**. Check for water accumulation at the surface of the jointing product as a cue to stop watering. Wait 30 seconds and verify the depth of activation. If NOCO™ is activated at 75% or more of its depth stop watering. If activated at less than 75%, water for an additional 15 seconds and check again after 30 seconds. Avoid overwatering NOCO™ as this will significantly lengthen the curing time and may compromise product performance.

For large slabs* with 6 mm (¼”) joint: with your sprayer set at shower, starting at the bottom of the slope, **water each section of 9.2 m² (100 sq. ft.) for 20 seconds**. Check for water accumulation at the surface of the jointing product as a cue to stop watering. Wait 30 seconds and verify the depth of activation. If NOCO™ is activated at 75% or more of its depth stop watering. If activated at less than 75%, water for an additional 10 seconds and check again after 30 seconds. Avoid overwatering NOCO™ as this will significantly lengthen the curing time and may compromise product performance.

*It is very easy to overwater installations with large slabs. Carefully track the watering time during the activation process.

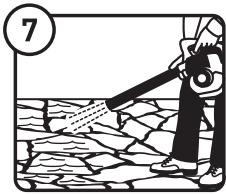

Use the leaf blower to remove all excess water from the surface.

END OF SUB-SECTION FOR INSTALLATION ON DRAINING BASE

INSTALLATION ON CONCRETE OVERLAY WITH JOINT WIDTH FROM 6 mm (1/4”) TO 100 mm (4”) (INCLUDING FALSE JOINTS)

The hardscape products should be installed following the manufacturer’s recommendation. Prior to applying NOCO™, make sure that the pavers, stones or slabs are well embedded in the bedding layer. For **flagstone**, the Natural Stone Institute guideline should be followed (www.naturalstoneinstitute.org). For **pavers and slabs**, ICPI Technical Specification Spec #10 and #20 (www.icpi.org) should be used for drainage hole dimension, position and slope requirements.

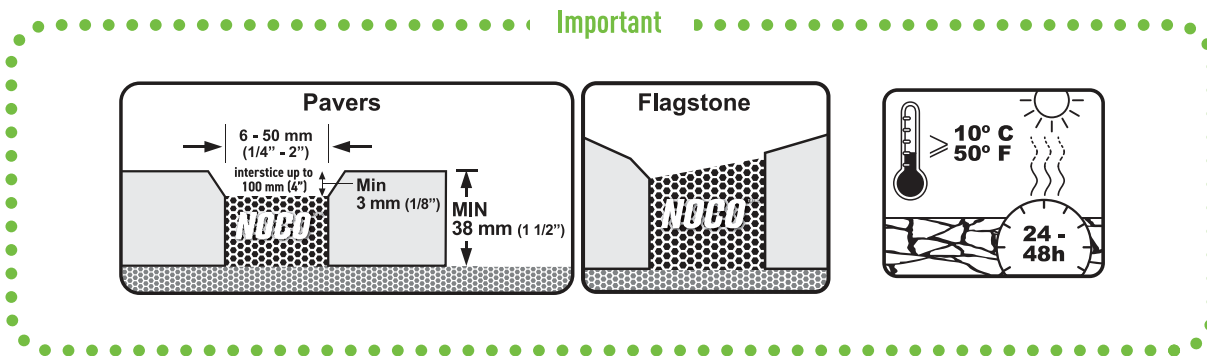

Installation - Important

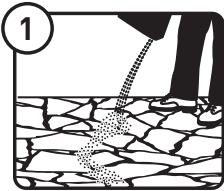

Spread product evenly on a small surface.

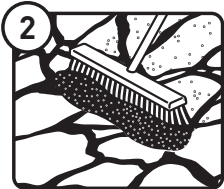

Using the street broom, fill joints completely. Sweep NOCO™ over **short distances**.



Remove excess NOCO™ from the surface with the broom.

Optional

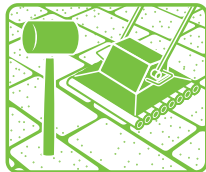

A slab and paver roller compactor or a rubber mallet can be used to compact NOCO™.

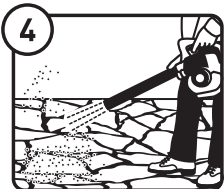

Level the joint height of NOCO™ and **remove all NOCO™ residue from the surface with the leaf blower.**

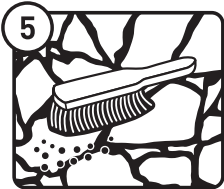

Using the small brush, smooth down the NOCO™ joint to ensure a uniform finish after activation.

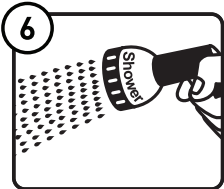

For joints up to 13 mm (1/2"): wet 20 sec/9,2 m² (100 sq. ft.).

For joints 13-100 mm (1/2" to 4"): wet up to 45 sec/4,5 m² (50 sq. ft.). Stop showering when you see water retention on the joints.

NOCO™ ACTIVATION INSTRUCTION FOR TYPICAL INSTALLATION ON CONCRETE OR CEMENT-SAND BASE

For Flagstones with joints up to 50 mm (2"), intersecting spaces up to 100 mm (4") and stone thickness up to 50 mm (2"): with your sprayer set at shower, starting at the bottom of the slope, **water each section of 4.5 m² (50 sq. ft.) for 30 to 45 seconds**. Check for water accumulation at the surface of the jointing product as a cue to stop watering. Wait 30 seconds and verify the depth of activation. If NOCO™ is activated at 75% or more of its depth stop watering. If not, water for an additional 15 seconds. Adjust watering time for the next sections. Aim to achieve complete saturation of the joint in one pass. Overwetting the joint will lengthen the cure time.

For imitation European cobblestones with joint with approximately 13 mm (½") and joint depth 38 mm (1 ½"): with your sprayer set at shower, starting at the bottom of the slope, **water each section of 9.2 m² (100 sq. ft.) for 20 to 30 seconds**. Check for water accumulation at the surface of the jointing product as a cue to stop watering. Wait 30 seconds and verify the depth of activation. If NOCO™ is activated at 75% or more of its depth stop watering. If not, water for an additional 10 seconds and check again after 30 seconds. Avoid overwatering NOCO™ as this will significantly lengthen the curing time and may compromise product performance.

For large slabs* with 6 mm (¼") joint with your sprayer set at shower, starting at the bottom of the slope, **water each section of 9.2 m² (100 sq. ft.) for 20 seconds**. Check for water accumulation at the surface of the jointing product as a cue to stop watering. Wait 30 seconds and verify the depth of activation. If NOCO™ is activated at 75% or more of its depth stop watering. If activated at less than 75%, water for an additional 10 seconds and check again after 30 seconds. Avoid overwatering NOCO™ as this will significantly lengthen the curing time and may compromise product performance.

*It is very easy to overwater installations with large slabs. Carefully track the watering time during the activation process.

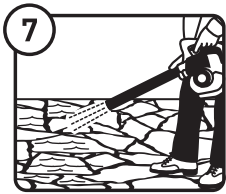

Use the leaf blower to remove all excess water from the surface.

END OF SUB-SECTION FOR INSTALLATION ON CONCRETE OVERLAY

INSTALLATION ON A DRAINING BASE WITH PORCELAIN TILES (JOINT WIDTH FROM 4 MM (5/32") TO 10 MM (3/8"))

The hardscape products should be installed following the manufacturer's recommendation.

Compaction Information:

For porcelain tiles, use a paver roller. **Do not use a plate compactor.**

Caution specific to porcelain tiles:

Mechanical compaction should be done until joint is saturated. Several passes may be required.

Always pre-compact and strike off your sand leveling course before installing your porcelain pavers in sand-set installations.

Water must be able to drain through the native soils or any other appropriate aggregate located underneath the installation. In areas where water is unable to evacuate, excessive moisture and humidity will buildup which will negatively impact the performance of the polymeric joint.

Necessary Tools:

- Street broom with semi-rigid bristles.
- Paver roller.
- **Paver rollers** such as Weber MT's VPR 450 & VPR 700, EZG's EVPC120, ESI's EVPC120H are examples of models that can be used to ensure proper mechanical compaction. Use of rubber-coated or nylon rollers is important to help protect the surface.

- Hand tamper may be needed in restricted areas where using heavier equipment may not be possible.
- Leaf blower.
- Spray nozzle and garden hose.

Installation - Important

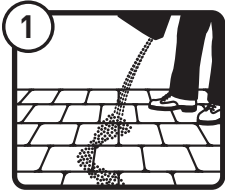

1 Spread product evenly on a small surface.

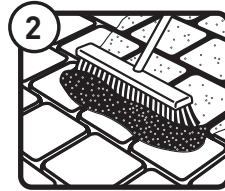

2 Using the street broom, fill joints completely. Spread sand over **short distances**.

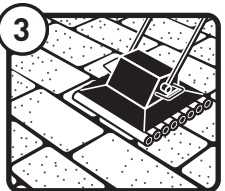

3 Pass the paver roller over the entire surface to compact the sand.



4 Spread more product to fill joints again.

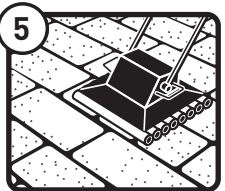

5 Pass the paver roller over the entire surface a second time. **Multiple passes** may be required until joint saturation is reached.

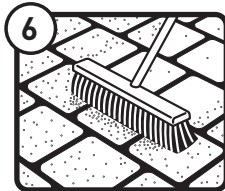

6 Remove excess sand from the surface with the broom.

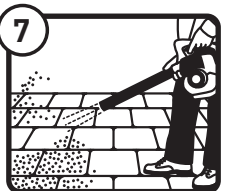

7 Level the height of the sand with the leaf blower.

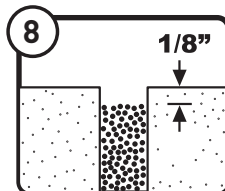

8 Sand level must be at least 1/8" below top of tiles.

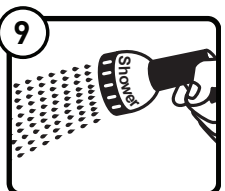

9 Starting from bottom of the slope, water each section of 100 sq. ft. for 20 to 30 seconds.

Check for water accumulation at the surface of the jointing sand as a cue to stop watering. Wait until there is no free water at the surface of the joint and verify the depth of activation. If NOCO™ is activated at 75% or more of its depth stop watering. If activated at less than 75%, water for an additional 10 seconds and check again after 30 seconds. Avoid overwatering NOCO™ as this will significantly lengthen the curing time and may compromise product performance.

*It is very easy to overwater installations with porcelain tiles. Carefully track the watering time during the activation process.

END OF SUB-SECTION FOR INSTALLATION ON DRAINING BASE WITH PORCELAIN TILES

COVERAGE

For a 22.7 kg (50 lb) bag:

Joints up to 13 mm (½"): up to 11 m² (120 sq. ft.) per bag.

Wide joints (flagstone): 1,85 to 4 m² (10 to 40 sq. ft.) per bag. For a more precise evaluation of the coverage, please refer to the product calculator at techniseal.com.

The amount required will depend on the shape and size of the stones, slabs, tiles and pavers, as well as the width and depth of the joints.

STORAGE

Unused bags can be stored outside if they are still on a pallet and protected by the original packaging.

WARNING

For more information and advice on the proper handling, storage, and disposal of this product, please refer to the latest version of its Safety Data Sheet (SDS). This official document contains physical, ecological, and other important information pertaining to the safe usage of this product. Visit www.techniseal.com or call 1-800-465-7325 to request or find an up-to-date version of this product's Safety Data Sheet (SDS).

KEEP OUT OF REACH OF CHILDREN

TRANSPORT

For more information and advice on the proper handling and transportation of this product, please refer to the latest version of its Safety Data Sheet (SDS). Visit www.techniseal.com or call 1-800-465-7325 to request or find an up-to-date version of this product's Safety Data Sheet (SDS).

PACKAGING

Jointing Sand Product	Product Code	Colour	Retail Size	Units per pallet
NOCO™	40104121	Desert Tan	22,7 kg / 50 lb (bag)	56
	40104120	Iron Grey	22,7 kg / 50 lb (bag)	56

TECHNICAL INFORMATION

Properties	Test method	Specification
Mohs Hardness Scale		>5 for grey >6 for tan
Compression Strength	ASTM C-109*	> 750 psi (5,2 MPa)
Water Absorption (15 minutes)	ASTM C-642*	< 5%

*Sample preparation adapted for water activated product. Compression Strength measured on non-vibrated sample.

LIMITED 20-YEAR WARRANTY

Manufacturer, having no control over the use of this Product, does not guarantee finished work. This Limited 20-Year Warranty (hereinafter "warranty"), exclusively covers all residential installations (single or multi-unit exclusively residential). Replacement or refund of any product proven defective shall be the buyer's sole remedy under this warranty. This product will perform its intended function when installed in accordance with its packaging instructions, technical data sheets instructions, and standard industry practices (ICPI Tech Spec #2). It is the sole responsibility of the user to determine the suitability and compatibility of this product for the intended use before installing it. No representation, promise, pre-approval, affirmation, statement, or demonstration by any employee of TECHNISEAL® or its distributors shall modify or supersede the terms of this warranty. This warranty applies only to NOCO™ used on the installation, and replaces all previous warranties. This warranty lasts so long as the job installation remains unchanged by the original owner and is none transferable, and shall end as specified in this warranty. To the extent permitted by law, all other warranties, including, but not limited to, IMPLIED WARRANTIES OF MERCHANTABILITY AND FITNESS FOR A PARTICULAR PURPOSE, ARE EXCLUDED. ANY IMPLIED WARRANTIES ARISING BY OPERATION OF LAW ARE LIMITED IN DURATION TO THE TERM OF THIS EXPRESS LIMITED WARRANTY.

Manufacturer will not be liable for damage or loss resulting from the following: structural failure; inadequate surface or sub-surface; inadequate job configuration; Acts of God; product misuse or modified; failure to comply with the packaging instructions, technical data sheets instructions, and standard industry practices; wear and tear from normal usage; cracking due to structural movement; excessive deflection due to heavy landscaping machinery, delivery truck, or waste collection truck or other failure of the substrate. IN NO EVENT SHALL TECHNISEAL® BE LIABLE FOR SPECIAL, INCIDENTAL, OR CONSEQUENTIAL DAMAGES, INCLUDING, BUT NOT LIMITED TO, DAMAGES FOR LOSS OF SALES OR PROFITS; BUSINESS INTERRUPTION OR DOWNTIME; INCREASED EXPENSE OF OPERATION; DAMAGE TO OTHER MATERIALS OR PROPERTY; OR LOSS OF USE OF PROPERTY. Proof of purchase is required for any claim. The above terms and conditions are applicable for commercial use, mix-use and institutional use except that the applicable period is limited to 1 year from the date of purchase.